



KT-ELECTRONIC

SOLAR ACCESSORIES



KT-Electronic Solar System specializes in the research, production and sales of solar modules and solar systems. Keeping our own fast developing strategy of international management, marketing and development we focusing on meeting the huge demands from the public in the near future and improving advanced customized solar system solution.

Index

SOLAR MEASURING INSTRUMENTS

PSMA-210 SOLAR MODULE ANALYZER	4
--------------------------------------	---

SYSTEM PROTECTION

SOLAR FUSES, HOLDERS & SPDs	5
-----------------------------------	---

SOLAR CABLES

SOLAR CABLES.....	8
-------------------	---

SOLAR CONNECTORS & TOOLS

CABLE ADAPTERS	9
----------------------	---

PV SOLAR T-BRANCH.....	10
------------------------	----

SOLAR CABLE COUPLER.....	12
--------------------------	----

APPENDIX	11
----------------	----

TOOLS	13
-------------	----

EXAMPLE OF USAGE	14
------------------------	----

SOLAR MOUNTING SYSTEMS

MOUNTING SYSTEM TYPES	15
-----------------------------	----

TILED ROOF SYSTEM.....	16
------------------------	----

FLAT ROOF SYSTEM A	19
--------------------------	----

FLAT ROOF SYSTEM B	21
--------------------------	----

TERRACE MOUNTING SYSTEM A	23
---------------------------------	----

TERRACE MOUNTING SYSTEM B	27
---------------------------------	----

SOLAR TRACKER SYSTEM	29
----------------------------	----

PSMA-210 Solar Module Analyzer

Features

- Four-wire Measurement
- I-V Curve Test for Solar Cell
- Maximum Solar Power (Pmax) Search by Auto-scan (60V, 12A)
- Maximum Voltage (Vmp) at Pmax
- Maximum Current (Imp) at Pmax
- Voltage at open circuit (Voc)
- Current at short circuit (Ishort)
- Manual I-V curve with cursor
- Efficiency (%) Calculation of solar panel
- Capable to logging daily I-V characteristic curve
- Scan delay (parameter) setting (0 ~ 9999 ms)
- Solar panel dimension (parameter) setting.(0.001 ~ 9999 Cm²)
- Standard light source (parameter) setting.(250, 500, 750,1000 W/m²)
- Min. power (parameter) setting and alarm. (1 mW ~ 100 W)
- Rechargeable batteries; LCD displays low battery
- Option: Printer (model: 300XP) to hard copy I-V curve



Specifications

DC Voltage Range (60V / 12A)	Resolution	Accuracy
0-6V	0.001V	±1% ± (1% of Vopen ± 9mV)
6 - 10V	0.001V	±1% ± (1% of Vopen ± 0.09V)
10-60V	0.01V	±1% ± (1% of Vopen ± 0.09V)

Vopen: open circuit voltage of solar cell or module.

DC Current Range (60V / 12A)	Resolution	Accuracy
0-0.6A	0.1mA	±1% ± (1% of Ishort ± 0.9mA)
0.6 - 1A	0.1mA	±1% ± (1% of Ishort ± 9mA)
1-12A	1mA	±1% ± (1% of Ishort ± 9mA)

Ishort: short circuit current of solar cell or module
Internal Resistance at Ishort: 0.05 Ohm

DC Current Simulation Range (60V / 12A)	Resolution	Accuracy
0-1A	0.1mA	±1% ± 0.9mA
1-12A	1mA	±1% ± 9mA

* Max. duration of simulation is 9.999 seconds if power is less than 100W
* Duration of simulation is 10m seconds if power is greater than 100W

General specifications

AC Adaptor	AC 110V or 220V input, DC 12V / 3A output
Dimensions (L x W x H)	257 × 155 × 57 mm
Battery type	Li Ion 2500 mAh (11,1V)
Weight	1160g (Batteries included)
Operation environment	0°C - 50°C / 85% RH
Storage environment	-20°C - 60°C / 75% RH
Accessories	User manual, Software manual, Li Ion Battery, RS232C cable (to USB bridge), Software CD, AC adaptor, Kelvin Clips set

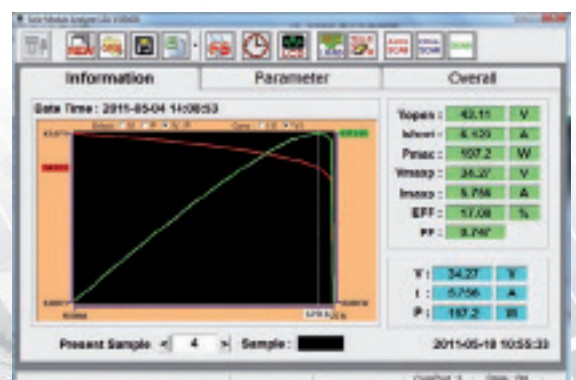

DC Solar Fuses, holders & SPDs

High performance surge protection products for all Photovoltaic applications. Finger-safe DIN-rail mount fuse holders protect your electrical system with simplify installation.



EAT•N
BUSSMANN
 SERIES

Specifications	PV-6A-10F	PV-10A-10F	PV-12A-10F	PV-15A-10F	PV-20A-10F
Current	6A	10A	12A	15A	20A
Voltage	1000V DC	1000V DC	1000V DC	1000V DC	1000V DC
Size	10 X 38mm	10 X 38mm	10 X 38mm	10 X 38mm	10 X 38mm



merseN

Specifications	HP10M25	HP10M30
Current	25A	30A
Voltage	1000V DC	1000V DC
Size	10 X 38mm	10 X 38mm

CHPV1U Solar Fuse Holder



EAT•N
BUSSMANN
 SERIES

Specifications

Rated Voltage: 1000V DC

Rated Current: 30A

Max. fuse link power dissipation: 3W

Cross section of connecting wire: 1,5-2,5mm²

Pole built in width: 18mm

Munting on the rail: EN 60715

Fuse size: 10X38

Standard. Fuse-links :IEC 60269-2:2006 UL 284-4

Standard - Fuse disconnecter: IEC 60947-1 Ed. 4.0 EN 60947-1:1999+A1+A2; IEC 60947-3 Ed. 2.1 EN 60947-3:1999+A1:2001

DC Solar SPDs

DCB YPV 1200



Specifications

SPD according to EN 50539-11	type 1 + type 2
Max. PV voltage [DC+ -> DC-] (UCPV)	≤ 1200 V
Max. PV voltage [DC+/DC- -> PE] (UCPV)	≤ 1200 V
Short-circuit current rating (ISCPV)	10000 A
Nominal discharge current (8/20 μs) (In)	20 kA
Total discharge current (10/350 μs) [DC+/DC- -> PE] (Itotal)	12.5 kA
Lightning impulse current (10/350 μs) [DC+ -> PE/DC- -> PE] (Iimp)	6.25 kA
Voltage protection level [(DC+/DC-) -> PE] (UP)	3.8 kV
Voltage protection level [DC+ -> DC-] (UP)	3.8 kV
Response time (tA)	≤ 25 ns
Operating temperature range (TU)	-40 °C ... +80 °C
Operating state / fault indication	green / red
Number of ports	1
Cross-sectional area (min.)	1.5 mm ² solid / flexible
Cross-sectional area (max.)	35 mm ² stranded / 25 mm ² flexible
For mounting on	35 mm DIN rails acc. to EN 60715
Enclosure material	thermoplastic, red, UL 94 V-0
Place of installation	indoor installation
Degree of protection	IP 20
Dimensions	4 module(s), DIN 43880
Weight	509 g

DCU YPV SCI 1000 - 1M/2M



Specifications

SPD according to EN 50539-11	type 2
Max. PV voltage (UCPV)	≤ 1000 V
Short-circuit withstand capability (ISCPV)	1000 A
Total discharge current (8/20 μs) (Itotal)	40 kA
Nominal discharge current (8/20 μs) [(DC+/DC-) --> PE] (In)	12.5 kA
Max. discharge current (8/20 μs) [(DC+/DC-) --> PE] (Imax)	25 kA
Voltage protection level (UP)	≤ 4 kV
Voltage protection level at 5 kA (UP)	≤ 3.5 kV
Response time (tA)	≤ 25 ns
Operating temperature range (TU)	-35 °C ... +80 °C
Operating state / fault indication	green / red
Number of ports	1
Cross-sectional area (min.)	2.5 mm ² solid / flexible
Cross-sectional area (max.)	6 mm ² solid / flexible
Place of installation	outdoor
Degree of protection	IP 65
Type	with pressure compensating element
Cover	transparent cover with product label
Colour of enclosure	grey
Number of cable entries	3x Ø3-7 mm
Enclosure dimensions (w x h x d)	94 x 94 x 81 mm
Weight	426 g

AC Solar SPDs

DSH TNS/TNC 255



Specifications

SPD according to EN 61643-11 / IEC 61643-11	type 1 + type 2 / class I + class II
Nominal a.c. voltage (UN)	230 / 400 V (50 / 60 Hz)
Max. continuous operating a.c. voltage (UC)	255 (50 / 60 Hz)
Lightning impulse current (10/350 μs) [L1+L2+L3+N-PE] (Itotal)	50 kA
Lightning impulse current (10/350 μs) [L, N-PE] (Iimp)	12.5 kA
Nominal discharge current (8/20 μs) [L/N-PE]/[L1+L2+L3+N-PE] (In)	12.5 / 50 kA
Voltage protection level [L-PE]/[N-PE] (UP)	≤ 1.5 / ≤ 1.5 kV
Follow current extinguishing capability a.c. (Ifi)	25 kArms
Follow current limitation / Selectivity	no tripping of a 32 A gL/gG fuse up to 25 kArms (prosp.)
Response time (tA)	≤ 100 ns
Max. mains-side overcurrent protection	160 A gL/gG
Temporary overvoltage (TOV) [L-N] (UT) – Characteristic	440 V / 120 min. – withstand
Operating temperature range (TU)	-40 °C ... +80 °C
For mounting on	35 mm DIN rails acc. to EN 60715
Degree of protection	IP 20
Capacity	4 module(s), DIN 43880
Weight	525 g

DVM TNS/TNC 255



Specifications

SPD according to EN 61643-11 / IEC 61643-11	type 1 + type 2 / class I + class II
Nominal a.c. voltage (UN)	230 / 400 V (50 / 60 Hz)
Max. continuous operating a.c. voltage (UC)	264 V (50 / 60 Hz)
Lightning impulse current (10/350 μs) [L1+L2+L3+N-PE] (Itotal)	100 kA
Lightning impulse current (10/350 μs) [L, N-PE] (Iimp)	25 kA
Nominal discharge current (8/20 μs) [L/N-PE]/[L1+L2+L3+N-PE] (In)	25 / 100 kA
Voltage protection level [L-PE]/[N-PE] (UP)	≤ 1.5 / ≤ 1.5 kV
Follow current extinguishing capability a.c. (Ifi)	50 kArms
Follow current limitation / Selectivity	no tripping of a 20 A gL/gG fuse up to 50 kArms (prosp.)
Response time (tA)	≤ 100 ns
Max. backup fuse (L) up to 1k = 50 kArms	315 A gL/gG
Temporary overvoltage (TOV) [L-N] (UT) – Characteristic	440 V / 120 min. – withstand
Operating temperature range [parallel] / [series] (TU)	-40 °C ... +80 °C -40 °C ... +60 °C
For mounting on	35 mm DIN rails acc. to EN 60715
Degree of protection	IP 20
Capacity	8 module(s), DIN 43880
Weight	1,35 kg

Solar Cables

Application:

These cables are special designed for connection of element of solar system inside and outside building. The applications include connection to module junction boxes; required cable routing in balance of system integration. Free movable, free hanging and buried in ground in constructional covered systems. Resistant against ozone, UV resistance, and weather influences. The cable is unsuitable for direct burial underground. Rated 600V UL and 1000V TÜV.

Features

- Flexible
- Easy to strip
- Halogen free
- Ozone and UV resistance
- Optional rodent resistance

Costruction

Conductor	Tinned copper conductor according to class 5 of IEC 60228
Core insulation	Special XL-HFFR (Crosslink Halogen Free Flame Retardant) compound
Insulation	White, red or blue
Outer sheath	Special XL-HFFR compound with Rodent protective colour: black, red or blue

Properties

Operating voltage U0/U	0.6/1 kV AC max 1.8 kV DC
Test voltage in production	10000 V DC
Temperature range	Ambient -40 to +90 °C, max conductor temperature 120 °C for 20.000 h
Short circuit temperature	200 °C
Bending radius	5 X Outer diameter

General

Standard	TÜV /EN 50521:2008
Outer marking	® 1 x 4 mm ² + UV PV1-F TÜV CE Red hot chili rodent protected (option)
Further information	Excellent ozone and UV resistance and 25 years lifetime
Flame retardant	According to EN 60332-1-2
Halogen free	According to EN 50267-2-1 and EN 60684-2
Lifetime	25 years



SCA-BC-04



SCA-BC-06



SCA-BC-10

Specifications

	4 mm ²	6 mm ²	10 mm ²
Cross-section	4 mm ²	6 mm ²	10 mm ²
Outer Diameter	6,05 ± 0,20mm	7,15 ± 0,20mm	9,00 ± 0,20mm
Ω / km 20°C (Conductor)	≤ 5,09 Ω/km	≤ 3,93 Ω/km	≤ 1,95 Ω/km
Cu-No.	36,27 kg/km	56,03 kg/km	94,87 kg/km
Cable Weight	69 kg/km	108,5 kg/km	175,69 kg/km
Color	● Black, ● Red, ● Blue	● Black, ● Red, ● Blue	● Black, ● Red, ● Blue

According to: DIN VDE V 0126-3/ 12.06
EN 50262:1998 +A1+A2; EN 50521: 2008

Technical information about products can be changed without notification in advance. No rights can be derived from this specification.

Solar T-branch

- Photovoltaic branch for safe and simple parallel or series-parallel connection of Photovoltaic-Modules.
- Due to highly robustness, UV-resistance, the touch protection a high grade connection is guaranteed for 25 years.
- According to DIN V VDE V 0126-3/12.06, UL 1703 standard.



Multi-Contact

MC

STÄUBLI GROUP

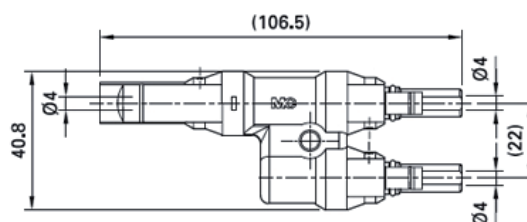

SC01/S - (PV-AZS 4)



Multi-Contact

MC

STÄUBLI GROUP

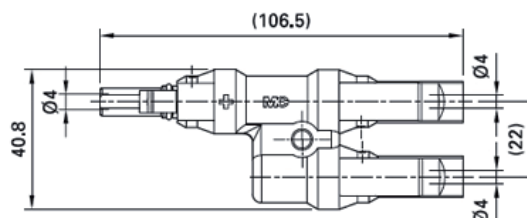

SC01/B - (PV-AZB 4)

Technical data of series SC01/S - SC01/B

Rated voltage	1000V (IEC)
Rated current*	30A
Contact resistance of plug connectors	≤5mΩ
Diameter of pin or socket	4mm
Locking system	Snap in Solar-4
Safety class	II
Degree of protection, Mated/ Unmated	IP67, IP2X
Flame class	UL94-V0
Ambient temperature	-40°C ... +85°C
Upper limiting temperature	100°C
Contact material	Copper, silver plated
UV resistance	ISO 4892-2 Method A

According to: DIN VDE V 0126-3/ 12.06
EN 50262:1998 +A1+A2; EN 50521: 2008

* The continuous, not interrupted current a connector can take when simultaneous power on all contacts is given, without exceeding the maximum temperature.

Solar Cable coupler

- Photovoltaic cable coupler.
- Due to highly robustness, UV-resistance, the touch protection a high grade connection is guaranteed for 25 years.
- According to DIN V VDE V 0126-3/12.06, UL 1703 standard.



Multi-Contact

MC

STÄUBLI GROUP

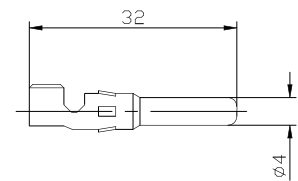
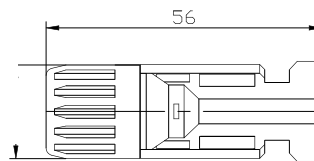

SC01/M - (PV-KST4/6 II-UR)



Multi-Contact

MC

STÄUBLI GROUP

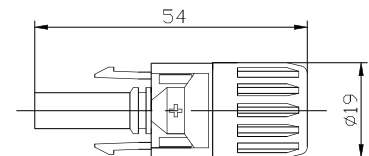
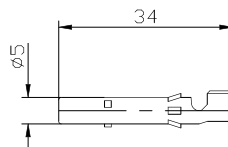

SC01/F - (PV-KBT4/6 II-UR)

Technical data of series SC01/S - SC01/B

Rated voltage	1000V (IEC)
Rated current*	30A
Contact resistance of plug connectors	≤5mΩ
Diameter of pin or socket	4mm
Locking system	Snap in Solar-4
Safety class	II
Degree of protection, Mated/ Unmated	IP67, IP2X
Flame class	UL94-V0
Ambient temperature	-40°C ... +85°C
Upper limiting temperature	100°C
Contact material	Copper, silver plated
UV resistance	ISO 4892-2 Method A

According to: DIN VDE V 0126-3/ 12.06
EN 50262:1998 +A1+A2; EN 50521: 2008

* The continuous, not interrupted current a connector can take when simultaneous power on all contacts is given, without exceeding the maximum temperature.

Appendix #1

Assembly instructions for connector of connectors

Female cable connector
SC01/F - (PV-KBT4/6 II-UR)



Male cable connector
SC01/M - (PV-KST4/6 II-UR)



- During self assembly, parts and tools other than those stated by Us are used or if the preparation and assembly instructions described here are disregarded then neither safety nor compliance with the technical data can be guaranteed.
- For protection against electric shock, Photovoltaic connectors must be isolated from the power supply while being assembled or disassembled.
- The end product must provide protection from electric shock.
- Unplugging under load: Photovoltaic plug connections must not be unplugged while under load. They can be placed in a no load state by switching off the DC / AC converter or breaking the AC circuit interrupter. Plugging and unplugging while under voltage is permitted.
- Disconnected connectors should be protected from dirt and water with sealing caps.
- Plugged parts are watertight IP67.

Technical data

Rated voltage	1000V
Rated current*	22A (2,5mm ²) 30A (4mm ² / 6mm ²)
Protection	IP67, IP2X
Ambient temperature	-40°C ... +85°C
Safety class	II

Type

Crimping ranges

Type	mm ²	AWG
SC01/F-1	2,5 / 4	12 / 14
SC01/M-1	2,5 / 4	12 / 14
SC01/F-2	4 / 6	10 / 12
SC01/M-2	4 / 6	10 / 12

Cable routing



Incorrect routing of cable



Correct routing of cable

* The continuous, not interrupted current a connector can take when simultaneous power on all contacts is given, without exceeding the maximum temperature.

Appendix #1

Application of series - PV cable plugs & PV T-branch

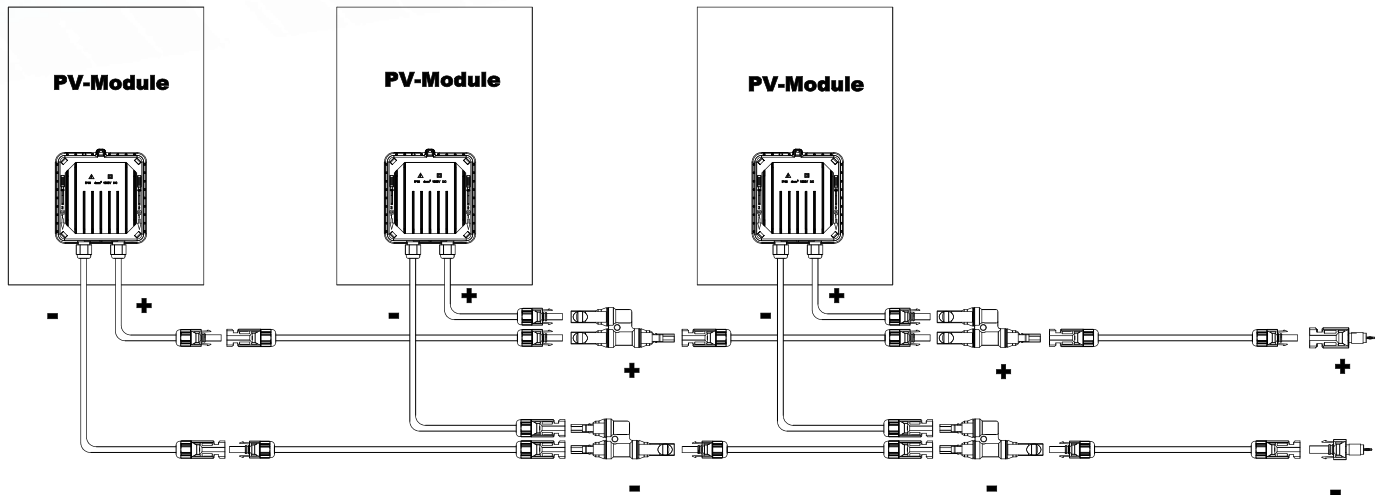

Plugging the connector (picture 1, 2 & 3)

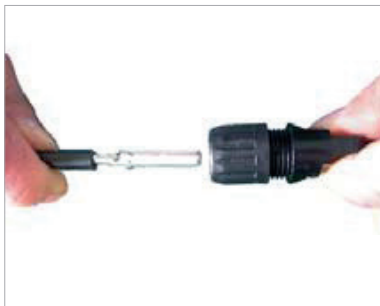

picture 1



picture 2

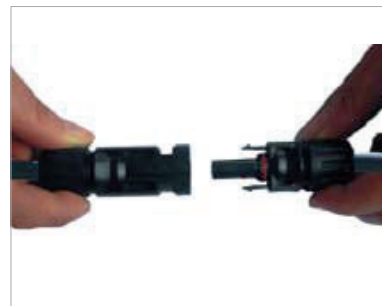

picture 3

Push the crimped contact into the socket resp. Plug insulator until it engages. Pull lightly on the lead to check that the metal part has engaged. Screw on the cable gland, hand-tight, with the tools TS-STX, tightening torque about: 2,2 Nm. Mount the connector together until they engage. Check correct engagement by pulling on the coupling.

Unplugging (picture 4 & 5)



picture 4



picture 5

Compress the two snap-in springs by hand or with the TS-STX tool and separate the coupling.

Tools

TS-BOX and TS-STX

TS-BOX



Aluminium box with foam cushion for solar tools.
All tools in one storage.

TS-STX



Open-end spanner TS-STX
1 Set = 2 pieces

TS-CE strip cable insulator



TS-CE

Check dimension „A” and „B” according to the following table:

Type	Range of cable gland mm	„B” Control dimension mm	Conductor cross section	
			mm ²	AWG
SC01/F-1 SC01/M-1	3 6/5,5 - 9	3	2,5	12mm
SC01/F-2 SC01/M-2	3 6/5,5 - 9	3	4-6	14mm

L=6 7,5mm. Take care not to cut individual strands of cable.

TS-CC crimping tool



TS-CC

Type	Crimp ranges	
	mm ²	AWG
SC01/F-1 SC01/M-1	2,5	12mm
SC01/F-2 SC01/M-2	4-6	14mm

Example of usage

Standalone PV system

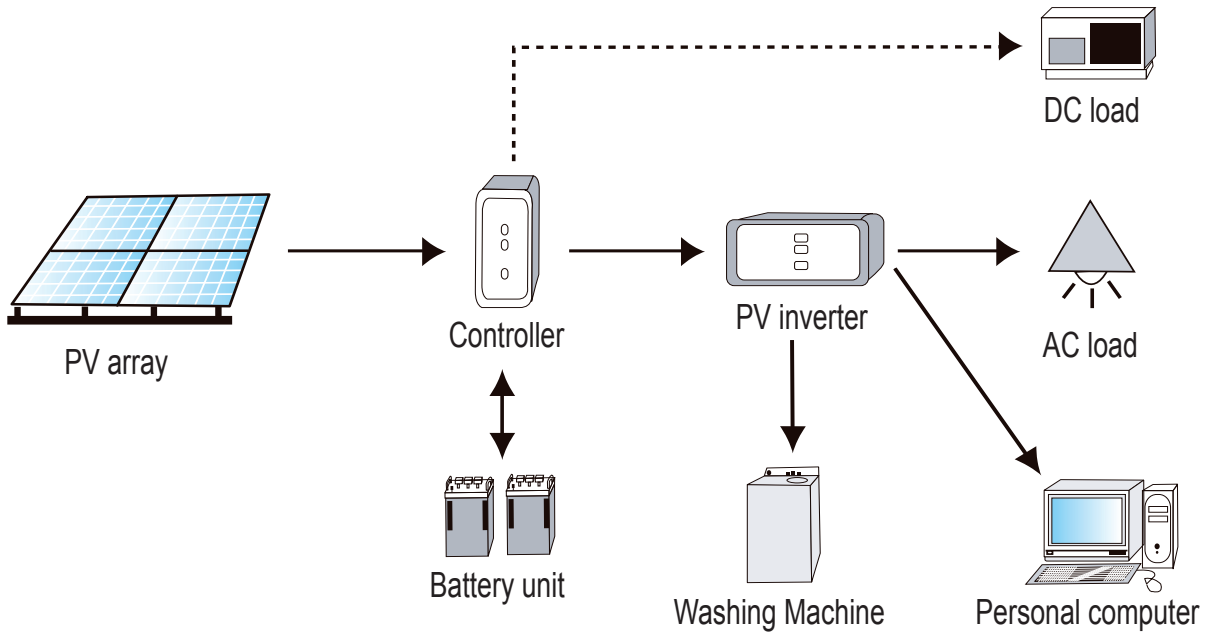

On-grid PV system

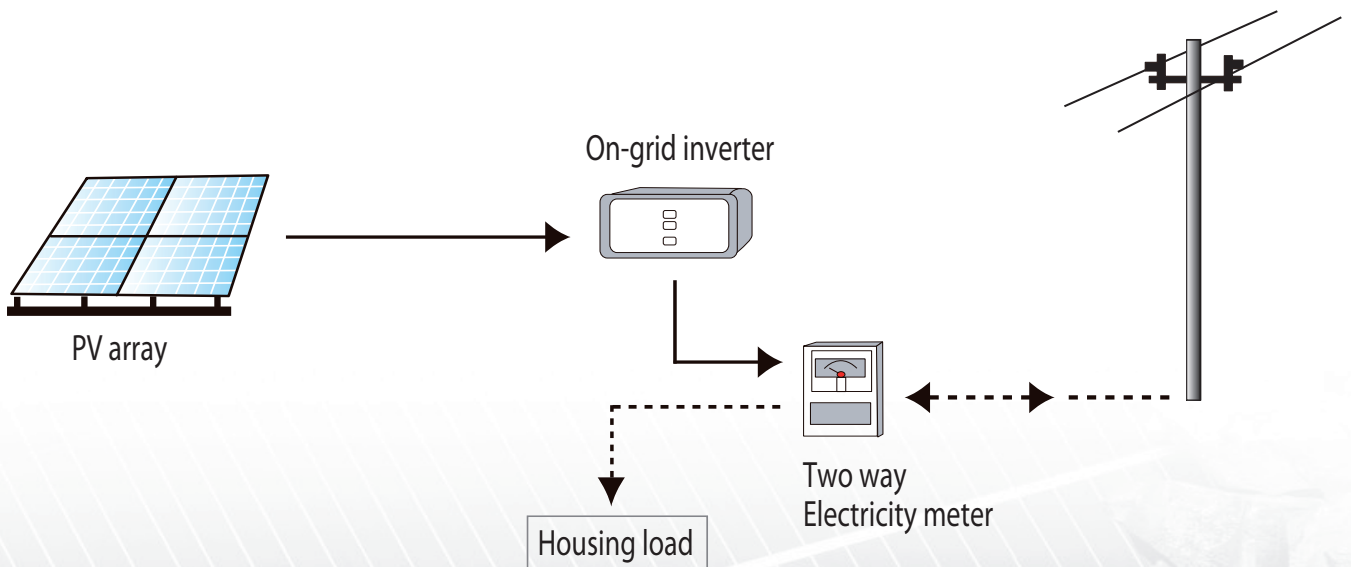

Tiled Roof System

The Tiled Roof System is engineered for the wide flexibility possible in designing and planning for the commercial and residential roof solar system. It is applicable to install the usual framed module.



Flat Roof System - A

The special extruded aluminum rail, special Z-NUT module, clamp kit and the various roof hooks can be high pre-assembly and make the installation easy and quick to save your labor cost and time.



Flat Roof System - B

The solar system can be a fixed angle or adjustable such as 10°-15°, 15°-30°. The special extruded aluminum rail, special Z-NUT module, clamp kit and the Adjustable Rear Leg Kits can be high pre-assembly and make the installation easy and quick to save your labor cost and time.



"Klikk" Mounting System

The Klikk mounting system has been developed as a universal PV modules mounting system for flat-roof installations. The innovative and practicality stainless steel brackets, the Matrix Legs are easy to install, with minimal parts, reduced labor expenses and the versatility to accommodate a wide range of modules.



Terrace Mounting System - A

The PV Quadruped system has been developed as a universal PV modules mounting system for open space ground installations. The Quadruped mounting systems are very high quality products designed to save you time and money on site.



Terrace Mounting System - B

It delivers flexible, effective and durable designs to mount 6 or 8 panels per pole. Our Post Mount systems are very high quality products designed to save you time and money on site. The innovative adjustable angle cap enables the angle to be easily and quickly adjusted from 0° to 60°.



Solar Tracker System

A solar tracker is a generic term used to describe devices that orient various payloads toward the sun. In standard photovoltaic applications trackers are used to minimize the angle of incidence between the incoming light and a photovoltaic panel. Sun trackers are more and more used to increase the electricity yield by more than 45% (dual-axis tracker) and 25% (single-axis tracker) compared to the fixed system.



Tiled Roof system

The Tiled Roof System is engineered for the wide flexibility possible in designing and planning for the commercial and residential roof solar system. It is applicable to install the usual framed module. The special extruded aluminum rail, special Z-NUT module, clamp kit and the various roof hooks can be high pre-assembly and make the installation easy and quick to save your labor cost and time. The customized length of rails can eliminate the weld and cut onsite to keep the high anticorrosive performance, the structure strength and the appearance.



Grate flexibility

The innovative patented rails and special Z-NUT modules have greatly Simplified the installation of PV modules. The System can be installed with a single Hexagon Key and standard tool kit. The Solar system is aided by a very high level of preassembly. The special Z-NUT module and unque rail extension method allow greatly reduced installation times.

Quick installation

Patented rail, Z module and unique adjustable cap eliminatethe need for onsite cutting, making the PV installation time and cost efficient.

High Quality

Strict quality control over materials and finished products ensure optimum strength and long life for your installation.

10-Year Warranty

Guaranteed Durability: All components are made of quality extruded aluminum and stainless steel. The high corrosion resistance guarantees the maximum possible lifespan and is also completely recyclable. It provides a 10 year product warranty for your peace of mind.

Features

- Installation Site: Pitched Roof (25° - 60°)
- Installation Angle: Parallel to the roof
- Building Height: <20m
- Wind Load: <60m/s (<216km/h)
- Snow Load: <1.4KN/m2
- Module Orientation: Vertical or Horizontal
- Module compatibility: Universal
- Material: Aluminum Alloy, Stainless Steel

Tiled Roof system

FTE-TAR-RA-01 Tile Interface 01



- Roof: Sloping roof
- Panel compability: universal
- Compability: universal Rail
- Quantity: ~1 pc/m/ rail
- Application: for rafter fixing, 45mm (tile and tile lath) height, max 96mm tile overlap
- Contain: 1 pc roof hook

FTE-TAR-RA-02 Tile Interface 02



- Roof: Sloping roof
- Panel compability: universal
- Compability: universal Rail
- Quantity: ~1 pc/m/ rail
- Application: for cover slat fixing, 32mm (tile and tile lath) height, max 180mm tile overlap
- Contain: 1 pc roof hook

FTE-TAR-RA-03 Tile Interface 03



- Roof: Sloping roof
- Panel compability: universal
- Compability: universal Rail
- Quantity: ~1 pc/m/ rail
- Application: for cover slat fixing, 32mm (tile and tile lath) height, max 180mm tile overlap
- Contain: 1 pc roof hook

Tiled Roof system

FTE-TAR-RA-04 Tile Interface 04



- Roof: Sloping roof
- Panel compability: universal
- Compability: universal Rail
- Quantity: ~1 pc/m/ rail
- Application: for rafter fixing, max 120mm tile overlap
- Contain: 1 pc roof hook

FTE-TAR-RA-06 Tile Interface 06



- Roof: Tin roof
- Panel compability: universal
- Compability: universal Rail
- Quantity: ~1 pc/m/ rail
- Application: for rafter fixing vertical rail structure, max 45mm High, max 70mm tile overlap
- Contain: 1 pc L-feet,

UNI-STPT-XXXX STPT Rack rail



- Panel compability: universal
- Compability: Z module
- Application: Tin roof, sloping roof, adjustable tilt flat roof
- Size: L x 34 (W) x 49 (H) mm

• 4200mm long rail module UNI-STPT-4200

UNI-STPT-KOT STPT Rail spice kit

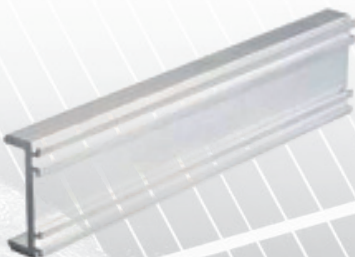

- Roof: universal
- Panel compability: universal
- Compability: „STPT” Shape 34x56mm Rail
- Quantity: 2 line / panel row / rail connection
- Size: 34x49x200 mm
- Application: for Rail connection, 34x49 rail
- Contain: 1 pc rail spice, 2 pcs A2 socket head screw

Flat Roof System - A

The Flat Roof System is engineered for the wide flexibility possible in designing and planning for the commercial and residential roof solar system. It is applicable to install the usual framed module. The special extruded aluminum rail, special Z-NUT module, clamp kit and the various roof hooks can be high pre-assembly and make the installation easy and quick to save your labor cost and time. The customized length of rails can eliminate the weld and cut onsite to keep the high anticorrosive performance, the structure strength and the appearance.



Grate flexibility

The innovative patented rails and special Z-NUT modules have greatly Simplified the installation of PV modules. The System can be installed with a single Hexagon Key and standard tool kit. The Solar system is aided by a very high level of preassembly. The special Z-NUT module and unque rail extension method allow greatly reduced installation times.

Quick installation

Patented rail, Z module and unique adjustable cap eliminatethe need for onsite cutting, making the PV installation time and cost efficient.

High Quality

Strict quality control over materials and finished products ensure optimum strength and long life for your installation.

10-Year Warranty

Guaranteed Durability: All components are made of quality extruded aluminum and stainless steel. The high corrosion resistance guarantees the maximum possible lifespan and is also completely recyclable. It provides a 10 year product warranty for your peace of mind.

Features

- Installation Site: Metal Roof
- Installation Angle: 0°-60°
- Building Height: <20m
- Wind Load: <60m/s (<216km/h)
- Snow Load: <1.4KN/m2
- Module Orientation: Vertical or Horizontal
- Module compatibility: Universal
- Material: Aluminum Alloy, Stainless Steel

Flat Roof System - A

FTE-TAR-RA-05 Tile Interface 05



- Roof: Tin roof
- Panel compability: universal
- Compability: universal Rail
- Quantity: ~1 pc/m/ rail
- Application: for rafter fixing, max 84mm High
- Contain: 1 pc Z Module, 1 pc L-feet, 1 pc Washer 8.4 DIN 9021 A2, 1 pc Lock washer 8 A2, 1 pc Hex head bolt M8x25 933 A2-70, Rubber pad, 1 pc Corrugated Screw G12x90

FTE-TAR-RA-07 Trapezoidal sheet roof Inteface

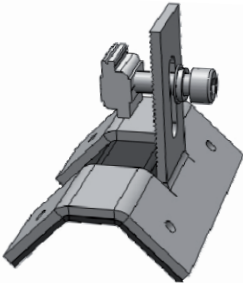

- Roof: Trapezoidal sheet roof
- Panel compability: universal
- Compability: universal Rail
- Quantity: ~1 pc/m/ rail
- Application: for peak fixing for trapezoidal sheet roof
- Contain: 1 pc Z Module, 1 pc L-feet, 1 pc Washer 8.4 DIN 9021 A2, 1 pc Lock washer 8 A2, 1 pc Hex head bolt M8x25 933 A2-70, Rubber pad, 4 pcs Corrugated tapping screw 5,5x38 V16

UNI-STPT-XXXX STPT Rack rail



- Panel compability: universal
- Compability: Z module
- Application: Tin roof, sloping roof, adjustable tilt flat roof
- Size: L x 34 (W) x 49 (H) mm
- 4200mm long rail module UNI-STPT-4200

UNI-STPT-KOT STPT Rail spice kit

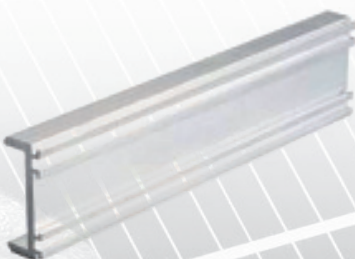

- Roof: universal
- Panel compability: universal
- Compability: „STPT” Shape 34x56mm Rail
- Quantity: 2 line / panel row
- Size: 34x49x200 mm
- Application: for Rail connection, 34x49 rail
- Contain: 1 pc rail spice, 2 pcs A2 socket head screw

Flat Roof System - B

The Adjustable Roof System is engineered for the extensive flexibility in designing and planning for the commercial and residential roof solar system. It is applicable to install the usual framed module. The solar system can be a fixed angle or adjustable such as 10°-15°, 15°-30°. The special extruded aluminum rail, special Z-NUT module, clamp kit and the Adjustable Rear Leg Kits can be high pre-assembly and make the installation easy and quick to save your labor cost and time. The customized length can eliminate the weld and cut onsite to keep the high anticorrosive performance, the structure strength and the appearance.



Grate flexibility

The innovative patented rails and special Z-NUT modules have greatly Simplified the installation of PV modules. The System can be installed with a single Hexagon Key and standard tool kit. The Solar system is aided by a very high level of preassembly. The special Z-NUT module and unque rail extension method allow greatly reduced installation times.

Quick installation

Patented rail, Z module and unique adjustable cap eliminatethe need for onsite cutting, making the PV installation time and cost efficient.

High Quality

Strict quality control over materials and finished products ensure optimum strength and long life for your installation.

10-Year Warranty

Guaranteed Durability: All components are made of quality extruded aluminum and stainless steel. The high corrosion resistance guarantees the maximum possible lifespan and is also completely recyclable. It provides a 10 year product warranty for your peace of mind.

Features

- Installation Site: Pitched Roof or Flat Roof (0° - 15°)
- Installation Angle: 10°-30°
- Building Height: <20m
- Wind Load: <60m/s
- Snow Load: <1.4KN/m2
- Module Orientation: Vertical or Horizontal
- Module compatibility: Universal
- Material: Aluminum Alloy, Stainless Steel

Flat Roof System - B

LTE-LBH-AL-1015 Adjustable Tilt leg (10-15°)

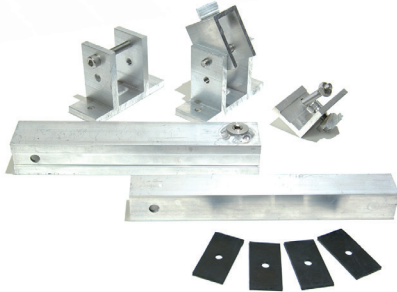

- Roof: Flat roof
- Panel compability: universal
- Compability: universal Rail
- Quantity: ~1 pc/m/ rail
- Application: for fixing to trapezoidal sheet roof
- Contain: 1 pc adjustable leg, 1 pc Leg(fix), 2pcs fix sole, 1 pc L profile, 4 pcs bkny Hex head bolt M8x25 A2-70 screw, 2pcs bkny Hex head bolt M8x55 A2-70 screw, 2pcs bkny Hex head bolt M8x45 A2-70 screw, 2pcs Z Module, 2 pcs Washer 8.4 DIN 9021 A2, 6 pcs Lock washer 8 A2, 4 pcs rubber sheet

LTE-LBH-AL-1530 Adjustable Tilt Leg (15-30°)

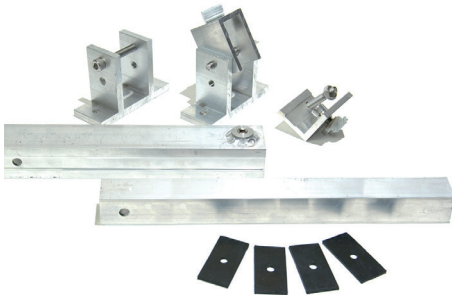

- Roof: Flat roof
- Panel compability: universal
- Compability: universal Rail
- Quantity: ~1 pc/m/ rail
- Application: for fixing to trapezoidal sheet roof
- Contain: 1 pc adjustable leg, 1 pc Leg(fix), 2pcs fix sole, 1 pc L profile, 4pcs bkny Hex head bolt M8x25 A2-70 screw, 2pcs bkny Hex head bolt M8x55 A2-70 screw, 2pcs bkny Hex head bolt M8x45 A2-70 screw, 2pcs Z Module, 2 pcs Washer 8.4 DIN 9021 A2, 6 pcs Lock washer 8 A2, 4 pcs rubber sheet

UNI-STPT-XXXX STPT Rack rail



- Panel compability: universal
- Compability: Z module
- Application: Tin roof, sloping roof, adjustable tilt flat roof
- Size: L x 34 (W) x 49 (H) mm
- 4200mm long rail module UNI-STPT-4200

UNI-STPT-KOT STPT Rail spice kit



- Roof: universal
- Panel compability: universal
- Compability: „STPT” Shape 34x56mm Rail
- Quantity: 2 line / panel row
- Size: 34x49x200 mm
- Application: for Rail connection, 34x49 rail
- Contain: 1 pc rail spice, 2 pcs A2 socket head screw

Terrace Mounting System - A

The Terrace PV Quadruped mounting system has been developed as a universal PV modules mounting system for open space ground installations. The Quadruped mounting systems are very high quality products designed to save you time and money on site. The system composed with Ø60mm galvanized and paint steel pipe and the innovative and anodized aluminum base rails, the special Z-NUT modules and the high degree of pre-assembly eliminate the need for onsite cutting, welding and enables quick and easy field PV module installations.

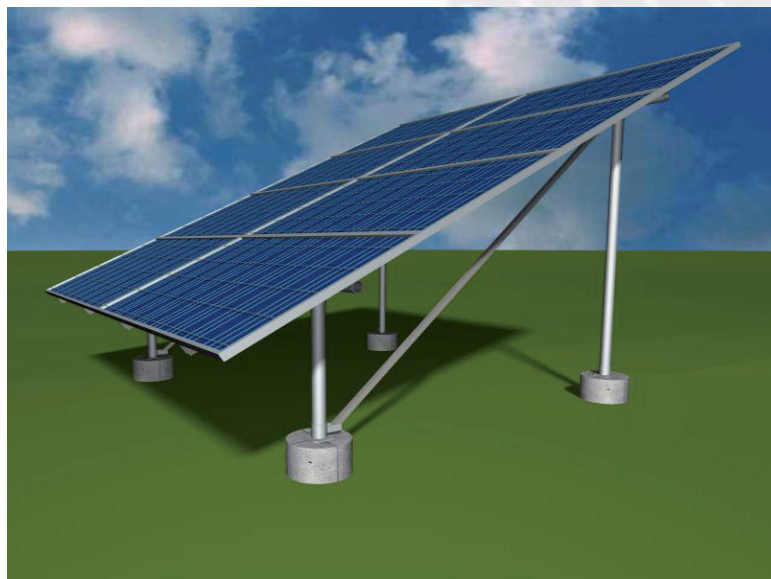

Grate flexibility

The PV Quadruped mounting system is a highly versatile ground mounted solution that can be used in almost all kinds of situations, from residential and large commercial, right through to utility scale. The innovative patented rails and special Z-NUT modules have greatly Simplified the installation of PV modules. The System can be installed with a single Hexagon Key and standard tool kit. The Solar system is aided by a very high level of preassembly. The special Z-NUT module and unque rail extension method allow greatly reduced installation times.

Excellent compatibility

Patented rail, Z module and unique adjustable cap eliminatethe need for onsite cutting, making the PV installation timeand cost efficient. Designed as a universal mounting system, PV PostMount is compatible with all of the major framed PV modules on the market

High quality

Strict quality control over materials and finished products ensure optimum strength and long life for your installation. The angle of the rails has been designed to maximum the harveast of solar power according to your local latitude.

Excellent Adaptability

The angle of the rails has been designed to maximum the harveast of solar power according to your local latitude.

10-Year Warranty

Guaranteed Durability: All components are made of quality extruded aluminum and stainless steel. The high corrosion resistance guarantees the maximum possible lifespan and is also completely recyclable. It provides a 10 year product warranty for your peace of mind.

Features

- Installation Site: Open field and Flat roof
- Installation Angle: <math><60^\circ</math>
- Building Height: <math><20\text{m}</math>
- Wind Load: <math><60\text{m/s}</math> (<math><216\text{km/h}</math>)
- Snow Load: <math><1.4\text{KN/m}^2</math>
- Module Orientation: Horizontal
- Module compatibility: Universal
- Material: Aluminum Alloy, Stainless Steel, Galvanized Steel Pipe

Terrace Mounting System - A

Galvanized Legs / Pipes



- Panel compability: universal
- Compability: „PTS” Shape 34×56mm Rail
- Quantity: 2-2 pcs/8 panel
- Application: ground mounted 8 palel island

• 850mm Front leg	Ø60mm	TAL-LBE-HO-850
• 2150mm Rear leg	Ø60mm	TAL-LBH-HO-2150
• 3000mm Cross pipe	Ø60mm	TAL-PTK-HO-3000

Galvanized Reinforcement Pipe

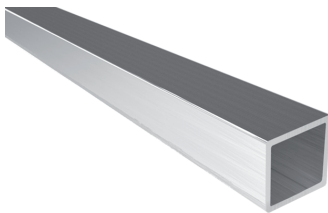

- Panel compability: universal
- Compability: „PTS” Shape 34×56mm Rail
- Quantity: 2 pcs/8 panel
- Application: ground mounted 8 palel island

• 2990mm Reinf. pipe	TAL-LBK-HO-2990
----------------------	-----------------

TAL-END-HO-01 Steel Cap Set



- Panel compability: universal
- Compability: Ø 60mm pipe
- Quantity: 2 set/8 panel
- Application: ground mounted 8 palel island
- Contain:
 - 1 pc steel cap for concrete fixation (120×120),
 - 1 pc steel cap for cross mount bracket (120×120),
 - Sets screws M8×6; Hex pan bolt M12×65;
 - Hex pan nut M12; Flat washer 12.4; Washer 12.4

TAL-END-HO-02 Steel Cap Set



- Panel compability: universal
- Compability: Ø 60mm pipe
- Quantity: 2 set/8 panel
- Application: ground mounted 8 palel island
- contain: 1 pc steel cap for concrete fixation(120×120),
- 1 pc steel cap for cross mount bracket (120×120),
- Sets screws M8×6; 2pcs U bolt; Hex pan bolt M12×70;
- Hex pan nut M12; Flat washer 12.4; Washer 12.4

Terrace Mounting System - A

TAL-U-A2-01 Steel Cap Set



- Panel compability: universal
- Compability: Ø 60mm pipe
- Quantity: 2 set/8 panel
- Application: ground mounted 8 palel island
- Contain: 1 pc steel cap for concrete fixation (120X120),
1 pc steel cap for cross mount bracket (120X120), Sets screws M8×6; 2pcs U bolt;
Hex pan bolt M12×70; Hex pan nut M12; Flat washer 12.4; Washer 12.4

TAL-PTR-PO-01 Angle Bracket for 60mm Pipe



- Panel compability: universal
- Compability: Ø 60mm pipe
- Quantity: 4 set/8 panel
- Application: ground mounted 6 or 8 palel island
- Contain: Angle Splice L module 150X50X50mm; Rubber pad; U bolt,
Hex pan nut M12, Z module, Hex head bolt A2-70 M8×25,
Hex head bolt A2-70 M8×25, Lock washer 8 A2, Flat Washer 12.4

UNI-PTS-AL-XXXX Rail module

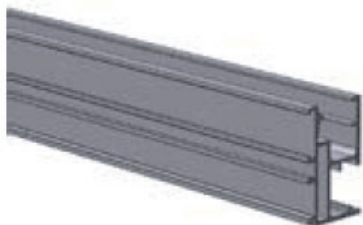

- Panel compability: universal
- Compability: Z module
- Application: Tin roof, sloping roof, adjustable tilt flat roof, ground mounting
- Size: L x 34 (W) x 56 (H) mm

- | | |
|---------------------------|-----------------|
| • 2456mm long rail module | UNI-PTS-AL-2456 |
| • 2560mm long rail module | UNI-PTS-AL-2560 |
| • 3049mm long rail module | UNI-PTS-AL-3049 |
| • 3260mm long rail module | UNI-PTS-AL-3260 |
| • 3405mm long rail module | UNI-PTS-AL-3405 |
| • 4064mm long rail module | UNI-PTS-AL-4064 |

FTE-KOT-AL-01 Rail Splice



- Roof: universal
- Panel compability: universal
- Compability: „PTS” Shape 34x56mm Rail
- Quantity: 2 line / panel row
- Size: 34x56x200 mm
- Application: for Rail connection, 34x56mm rail
- Contain: 1 pc rail spice, 2 pcs A2 socket head screw

Terrace Mounting System - A

UNI-PRV-AL-XX End Clamp



- Panel compability: universal with 35-50mm thickness
 - Compability: STPT Shape 34x49mm Rail
 - Application: Tin roof, sloping roof, adjustable tilt flat roof, ground mounting
 - Contain:
 - 1 pc Z Module,
 - 1 pc end clamp head,
 - 1 pc Washer 8.4 DIN 9021 A2,
 - 1 pc Lock washer 8 A2,
 - 1 pc Hex head bolt M8x25 / M8x25 screw
- | | |
|---------------------|---------------|
| • M8 x 35 End clamp | UNI-PRV-AL-35 |
| • M8 x 40 End clamp | UNI-PRV-AL-40 |
| • M8 x 45 End clamp | UNI-PRV-AL-45 |
| • M8 x 50 End clamp | UNI-PRV-AL-50 |

UNI-PRK-AL-XX Inter Clamp



- Panel compability: universal with 35-50 mm thickness
 - Compability: STPT Shape 34x49mm Rail
 - Application: Tin roof, sloping roof, adjustable tilt flat roof, ground mounting
 - Contain:
 - 1 pc Z Module,
 - 1 pc Inter clamp head,
 - 1 pc Washer 8.4 DIN 9021 A2,
 - 1 pc Lock washer 8 A2,
 - 1 pc Hex head bolt M8x25 screw
- | | |
|-----------------------|---------------|
| • M8 x 35 Inter clamp | UNI-PRK-AL-35 |
| • M8 x 40 Inter clamp | UNI-PRK-AL-40 |
| • M8 x 45 Inter clamp | UNI-PRK-AL-45 |
| • M8 x 50 Inter clamp | UNI-PRK-AL-50 |

UNI-ZMO-AL-M8x25 Z module



- Panel compability: universal
- Compability: STPT Shape 34x49mm Rail
- Application: Tin roof, sloping roof, adjustable tilt flat roof, ground mounting
- Contain:
 - 1 pc Z Module,
 - 1 pc Washer 8.4 DIN 9021 A2,
 - 1 pc Lock washer 8 A2,
 - 1 pc Hex head bolt M8x25 screw

Terrace Mounting System - B

Terrace Mounting B delivers flexible, effective and durable designs to mount 6 or 8 panels per pole. Our Post Mount systems are very high quality products designed to save you time and money on site. All Terrace Mounting system B PV Post Mount systems use our patented PV rails ensuring strength, flexibility and ease of installation. The innovative adjustable angle cap enables the angle to be easily and quickly adjusted from 0° to 60°.



10% more energy

The innovative steel cap and support pole allow the angle to be adjusted according to the seasonal sun altitude to maximize the generating efficiency.

Excellent compatibility

Patented rail, Z-module and unique adjustable cap eliminate the need for onsite cutting, making the PV installation time and cost efficient. Designed as a universal mounting system, PV PostMount is compatible with all of the major framed PV modules on the market

High quality

Strict quality control over materials and finished products ensure optimum strength and long life for your installation. The angle of the rails has been designed to maximize the harvest of solar power according to your local latitude.

10-Year Warranty

Guaranteed Durability: All components are made of quality extruded aluminum and stainless steel. The high corrosion resistance guarantees the maximum possible lifespan and is also completely recyclable. It provides a 10 year product warranty for your peace of mind.

Features

- Installation Site: Open field
- Installation Angle: <60°
- Building Height: <20m
- Wind Load: <60m/s (<216km/h)
- Snow Load: <1.4KN/m²
- Applicable module: Framed
- Module Orientation: Horizontal or Landscape
- Module compatibility: Universal
- Material: Aluminum Alloy, Stainless Steel, Galvanized Steel Pole

Terrace Mounting System - B

UNI-PRK-AL-XX Inter Clamp



- Panel compability: universal with 35 mm thickness
- Compability: „PTS” Shape 34x56mm Rail; STPT Shape 34x49mm Rail
- Application: Tin roof, sloping roof, adjustable tilt flat roof, ground mounting
- Contain:1 pc Z Module, 1 pc Inter clamp head, 1 pc Washer 8.4 DIN 9021 A2, 1 pc Lock washer 8 A2, 1 pc Hex head bolt M8x25 screw

UNI-PRV-AL-45 End Clamp 45mm



- Panel compability: universal with 35mm thickness
- Compability: „PTS” Shape 34x56mm Rail; STPT Shape 34x49mm Rail
- Application: Tin roof, sloping roof, adjustable tilt flat roof, ground mounting
- Contain:1 pc Z Module, 1 pc end clamp head, 1 pc Washer 8.4 DIN 9021 A2, 1 pc Lock washer 8 A2, 1 pc Hex head bolt M8x25 screw

TAL-TAM-100-XXXX Rectangular Tube Master



- Panel compability: 1640x990x45or 50mm
- Compability:”PTS” Shape 34x56mm Rail
- Set quantity: 1
- MAP6: 100x100x1700mm; MAP8:100x100x1980mm

TAL-TAB-80-XXXX Rectangular Tube Landscape



- Panel compability: 1640x990x45or 50mm
- Compability:”PTS” Shape 34x56mm Rail
- Set quantity:2
- MAP6: 70x70x2646 mm; MAP8:80x80x2646mm

TAL-TAA-100/506 Rectangular Tube Adjust



- Compability:”PTS” Shape 34x56mm Rail
- Set quantity: 1
- MAP6, MPA8: 100x50x506 mm

TAL-TAF-156 Steel Cap



- Compability:”PTS” Shape 34x56mm Rail
- Set quantity: 1
- MAP6: 70x70x2646 mm; MAP8:80x80x2646mm
- Contain: Steel cap 322.6x168x363, Screw M12x25, Lock Washer8, Hex Socket Head Bolt A2-70 M8x20, Hex Socket Head Bolt M12x100, Hex Socket Head bolt M20x1 60, Washer 12, Washer 20, Nut M12, Nut M20, Lock Washer 20, Z-Module

TAL-TKL-152/XXXX Post Mount Pole



- Set quantity: 1
- MAP6: L2900, Ø152x6mm; MAP8: L3100, Ø152x6mm

Solar Tracker System

A solar tracker is a generic term used to describe devices that orient various payloads toward the sun.

In standard photovoltaic applications trackers are used to minimize the angle of incidence between the incoming light and a photovoltaic panel. This increases the amount of energy produced from a fixed amount of installed power generating capacity.

Sun trackers are more and more used to increase the electricity yield by more than 45% (dual-axis tracker) and 25% (single-axis tracker) compared to the fixed system.



EFFICIENCY COMPARISON

Contents	Fixed deck	1 Axis Tracker	2 Axis Tracker
Position	Southern exposure (East / West 30°)	Elevation tracking (East -> West)	Elevation & Azimuth tracking (East -> West, South -> North)
Installation cost	100 %	115 %	120 %
Output	100 %	~ 125 %	~ 145 %

Tracking system improves the output & efficiency:

➔ **1 AXIS: ~ 25% more power**

➔ **2 AXIS: ~ 45% more power**

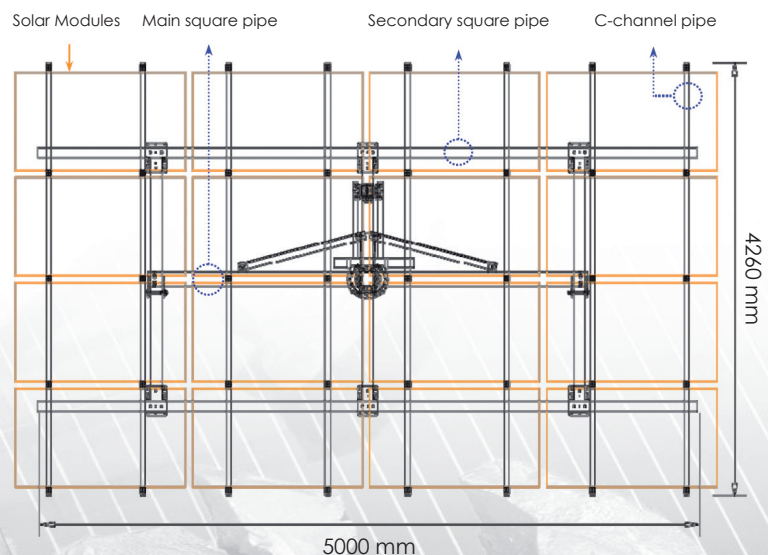

Solar Tracker System

SPECIFICATIONS

Models	3 kWp	5 kWp	6 kWp
Peak Capacity	< 3 kWp <	< 5kWp <	< 6kWp <
Tracking Technology	2 axis	2 axis	1 axis
Max. module surface	23 m2	41 m2	60 m2
Material of structure	Aluminium, zinc galvanized steel		zinc galvanized steel
Inclination of ground	10°	10°	10°
Power supply to drive motors	60W, DC24V, 3000 RPM	60W, DC24V, 3000 RPM	60W, DC24V, 3000 RPM
Power consumption	120W	120W	60W
Positioning precision	Max. ± 1°		
Azimuth angle / Roll angle	0 ~ 270°		0 ~ 320°
Azimuth rotation motor	3000 RPM, 3kg > 0.06 RPM		3000 RPM, 3 kg > 0.05 RPM
Azimuth rotation drive (Roll)	Tapered roller bearing	Tapered roller bearing	Ball bearing
Elevation angle	0 ~ 80°	0 ~ 80°	n/a
Elevation tilt motor	3000 RPM, 3kg > 100:1 > 30 RPM		n/a
Elevation tilt drive	Linear actuator	Linear actuator	n/a
Control panel	Six buttons: Auto, Manual (North, South, East, West)		
Remote control	Optional		
Monitoring	Optional		
Anemometer	Optional		
Drives can operate under wind	14 m/s ±1 (50 km/h)	14 m/s ±1 (50 km/h)	14 m/s ±1 (50 km/h)
Withstand wind maximum	35 m/s (126 km/h)	35 m/s (126 km/h)	35 m/s (126 km/h)
Withstand gust maximum	66.5 m/s (240 km/h)	66.5 m/s (240 km/h)	66.5 m/s (240 km/h)

SYSTEM COMPONENTS

6 kW

3 kW

PV Solar sensor

CPV Solar sensor

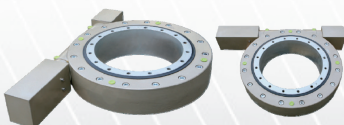

Worm drive



Real time solar sensor



Controller



Linear Actuator

www.solar.kte.hu

For in depth information of our products, please contact us!

KT-Electronic Kft.

2040 Budaörs, Gyár u. 2. (BITEP Ipari Park)

Tel.: 06 (23) 503 868 • Fax: 06 (23) 444 926

solar@kte.hu • www.solar.kte.hu